

产品规格书

PRODUCT SPECIFICATION

产品名称 (Model Name) <u>37.0液晶显示屏</u>			
产品型号 (Part Number) <u>H370HDL</u>			
项目 (Item)	拟制 (Prepared)	审核 (Checked)	批准 (Approved)
签名 (Signature)			
日期 (Date)			
备注 (Note)			
客户 (Customer): 签名 (Signature): 日期 (Date):			

版本介绍 (Version is introduced)				
版本 (Version)	发行日期 (Release date)	原版描述 (Old description)	更新描述 (New description)	页码 (Page)
V.0	2018/12/10	首版		/

1.0 GENERAL DESCRIPTION

1.1 Introduction

HT370HDL-500 is a color active matrix TFT LCD open cell using amorphous silicon TFT's (Thin Film Transistors) as an active switching devices. This open cell has a 37.0 inch diagonally measured active area with FHD resolutions (1920 horizontal by 720 vertical pixel array). Each pixel is divided into RED, GREEN, BLUE dots which are arranged in vertical stripe and this open cell can display 16.7M colors. The TFT-LCD panel used for this open cell is adapted for a low reflection and higher color type.

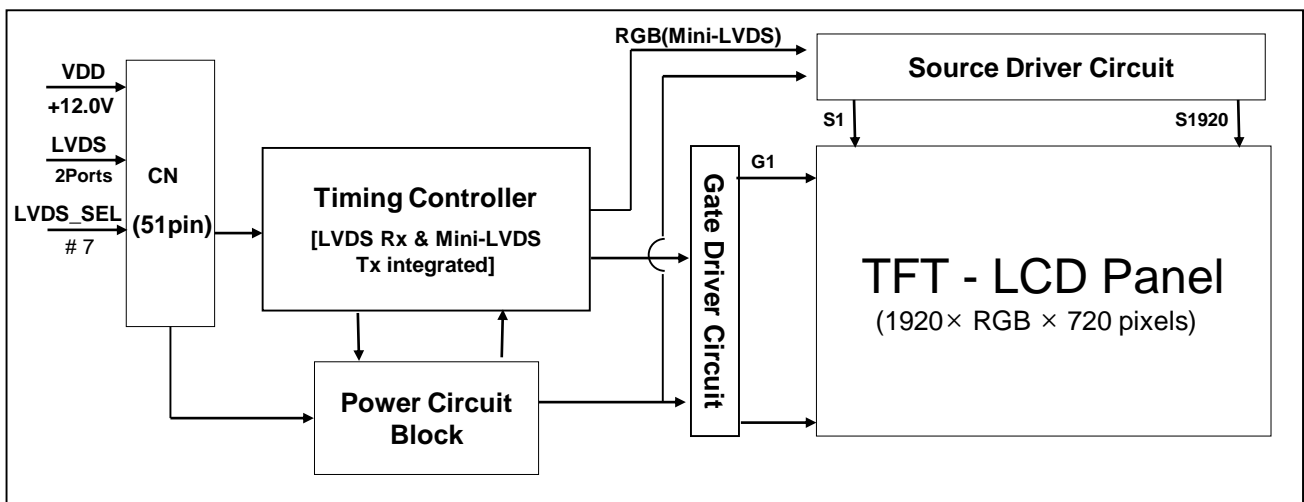

1.2 Features

- LVDS interface with 2 pixel / clock
- High-speed response
- Low color shift image quality
- 8-bit color depth, display 16.7M colors
- High luminance and contrast ratio, low reflection and wide viewing angle
- DE (Data Enable) only mode
- ADSDS technology is applied for high display quality
- RoHS compliant

1.3 Application

- Home Alone Multimedia TFT-LCD TV
- Display Terminals for Control System
- High Definition TV(FHD TV)
- AV application Products

1.4 General Specification

< Table 1. General Specifications >

Parameter	Specification	Unit	Remark
Active area	878.12(H) × 332.1(V)	mm	
Number of pixels	1920(H) × 720(V)	pixels	
Pixel pitch	0.4494(H) × RGB × 0.4494(V)		
Pixel arrangement	Pixels RGB Vertical stripe		
Display colors	16.7M(8bits-true)	colors	
Brightness	500cd type		
Open Cell Transmittance	5.0 (typ.)	%	At center point with BOE BLU
Weight	8000	gram	
Power Consumption	80	Watt	
Surface Treatment	Haze 1% , 3H, Anti-Glare Layer(for Front) , Clear(for Rear)		

2.0 ABSOLUTE MAXIMUM RATINGS

The followings are maximum values which, if exceed, may cause faulty operation or damage to the unit. The operational and non-operational maximum voltage and current values are listed in Table 2.

< Table 2. Open Cell Electrical Specifications > [VSS=GND=0V]

Parameter	Symbol	Min.	Max.	Unit	Remark
Power Supply Voltage	VDD	VSS-0.3	14	V	Ta = 25 °C
Operating Temperature	T _{OP}	0	+50	°C	Note 1
	T _{SUR}	0	+60	°C	
Storage Temperature	T _{ST}	-20	+60	°C	
Operating Ambient Humidity	Hop	10	80	%RH	
Storage Humidity	Hst	10	80	%RH	

Note 1 : Temperature and relative humidity range are shown in the figure below.
Wet bulb temperature should be 39 °C max. and no condensation of water.

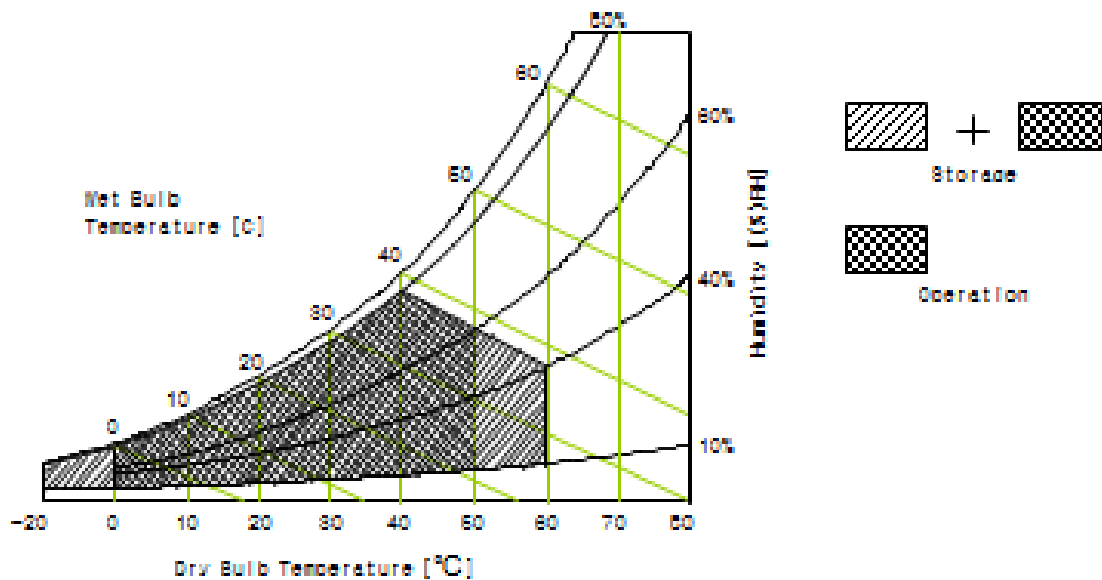

3.0 ELECTRICAL SPECIFICATIONS

3.1 TFT LCD Open Cell

< Table 3. Open Cell Electrical Specifications >

[Ta =25 ± 2 °C]

Parameter		Symbol	Values			Unit	Remark
			Min	Typ	Max		
Power Supply Input Voltage		VDD	10.8	12	14	Vdc	
Power Supply Ripple Voltage		VRP			300	mV	
Power Supply Current		IDD	-	333	630	mA	Note 1
Power Consumption		PDD		4.0	7.6	Watt	
Rush current		IRUSH	-	-	3.3	A	Note 2
LVDS Interface	LVDS Swing Voltage	VID	±100		±300	mV	Note 3
	Common Input Voltage	VLVC	1.0	1.2	1.4	V	
CMOS Interface	Input High Threshold Voltage	VIH	2.7	-	3.3	V	
	Input Low Threshold Voltage	VIL	0	-	0.6	V	

Note 1 : The supply voltage is measured and specified at the interface connector of LCM.

The current draw and power consumption specified is for VDD=12.0V,

Frame rate $f_v=60\text{Hz}$ and Clock frequency = 75.4MHz.

Test Pattern of power supply current

a) Typ : Mosaic 7X5 (L0/L255)

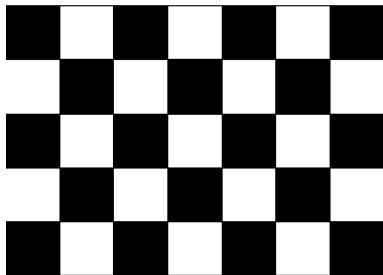

b) Max : Horizontal 1 Line (L0/L255)

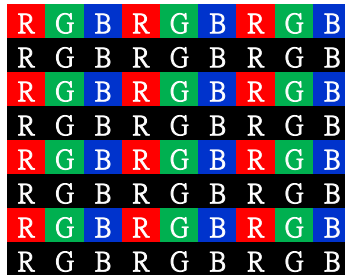

c) Flicker Pattern

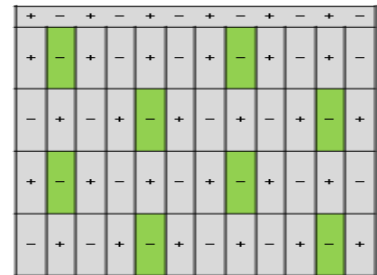

Note 2 : The duration of rush current is about 2ms and rising time of Power Input is 1ms(min)

Note 3 : The LVDS test point is at each terminal resistor

4.0 INTERFACE CONNECTION

4.1 Module Input Signal & Power

- Connector : IS050-C51B-C39-S (UJU) / FI-RE51S-HF-R1500 (JAE) or Equivalent.

< Table 4. Open Cell Input Connector Pin Configuration >

Pin No	Symbol	Description	Pin No	Symbol	Description
1	NC	No Connection	21	GND	Ground
2	SDA	I ² C Data	22	CH1[3]-	First pixel negative LVDS differential data input. Pair3
3	SCL	I ² C Clock	23	CH1[3]+	First pixel positive LVDS differential data input. Pair3
4	NC	Not Connected	24	NC	Not Connected
5	NC	Not Connected	25	NC	Not Connected
6	NC	Not Connected	26	NC or GND	Not Connected
7	SELLVDS	High: JEIDA Low or Open: VESA	27	NC	Not Connected
8	NC	Not Connected	28	CH2[0]-	Second pixel negative LVDS differential data input. Pair0
9	NC	Not Connected	29	CH2[0]+	Second pixel positive LVDS differential data input. Pair0
10	NC	Not Connected	30	CH2[1]-	Second pixel negative LVDS differential data input. Pair1
11	GND	Ground	31	CH2[1]+	Second pixel positive LVDS differential data input. Pair1
12	CH1[0]-	First pixel negative LVDS differential data input. Pair0	32	CH2[2]-	Second pixel negative LVDS differential data input. Pair2
13	CH1[0]+	First pixel positive LVDS differential data input. Pair0	33	CH2[2]+	Second pixel positive LVDS differential data input. Pair2
14	CH1[1]-	First pixel negative LVDS differential data input. Pair1	34	GND	Ground
15	CH1[1]+	First pixel positive LVDS differential data input. Pair1	35	CH2CLK-	Second pixel negative LVDS clock
16	CH1[2]-	First pixel negative LVDS differential data input. Pair2	36	CH2CLK+	Second pixel positive LVDS clock
17	CH1[2]+	First pixel positive LVDS differential data input. Pair2	37	GND	Ground
18	GND	Ground	38	CH2[3]-	Second pixel negative LVDS differential data input. Pair3
19	CH1CLK-	First pixel negative LVDS clock	39	CH2[3]+	Second pixel positive LVDS differential data input. Pair3
20	CH1CLK+	First pixel positive LVDS clock			

Pin No	Symbol	Description	Pin No	Symbol	Description
40	NC	Not Connected	46	GND	Ground
41	NC	Not Connected	47	NC	Not Connected
42	NC or GND	Not Connected	48	VCC	Input Voltage +12V
43	NC or GND	Not Connected	49	VCC	Input Voltage +12V
44	NC or GND	Ground	50	VCC	Input Voltage +12V
45	GND	Ground	51	VCC	Input Voltage +12V

- Notes :
1. NC(Not Connected) : This pins are only used for BOE internal operations.
 2. Input Level of LVDS signal is based on the IEA 664 Standard.
 3. LVDS_SEL : This pin is used for selecting LVDS signal data format.
 If this Pin : High (3.3V) → JEIDA LVDS format
 Otherwise : Low (GND) or Open (NC) → Normal NS LVDS format

Rear view of LCM

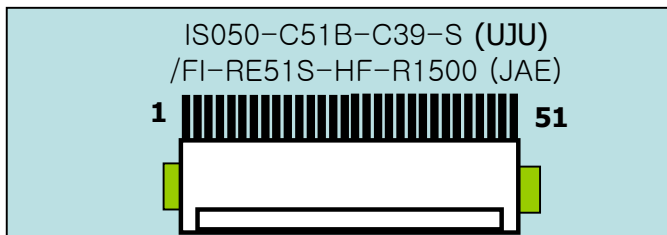

BIST Pattern

PT1: Black (1 sec)	PT1: White (1 sec)	PT1: Red (1 sec)	PT1: Green (1 sec)	PT1: Blue (1 sec)

5.0 SIGNAL TIMING SPECIFICATION

5.1 Timing Parameters (DE only mode)

< Table 5. Timing Table >

Item		Symbols	Min	Typ	Max	Unit	
Clock	Frequency	1/Tc	58	74.25 (92.8)	97	MHz	
	High Time	Tch	-	4/7Tc	-		
	Low Time	Tcl	-	4/7Tc	-		
Frame Period		Tv	1100	1125	1149	lines	
			47	60 (75)	78	Hz	
Horizontal Active Display Term		Valid	t _{HV}	-	960	-	t _{CLK}
		Total	t _{HP}	1060	1100	1200	t _{CLK}
Vertical Active Display Term		Valid	t _{VV}	-	360	-	t _{HP}
		Total	t _{VP}	1100	1125	1149	t _{HP}

Notes: This product is DE only mode. The input of Hsync & Vsync signal does not have an effect on normal operation.

< Table 6. LVDS Input SSCG >

Symbol	Parameter	Condition	Min	Typ	Max	Unit
F	LVDS Input frequency	-	58	74.25 (92.8)	97	MHz
T _{LVSK}	LVDS channel to channel skew	F=100MHz V _{IC} =1.2V V _{ID} =±200mV	-(1/F)* 30%	-	(1/F)*3 0%	ps
F _{LVMOD}	Modulating frequency of input clock during SSC	F=85MHz	0	-	200	KHz
F _{LVDEV}	Maximum deviation of input clock frequency during SSC	V _{IC} =1.2V V _{ID} =±200mV	-3	-	+3	%
T _{CY-CY}	Cycle to Cycle jitter		-	-	50	ps

5.3 Input Signals, Basic Display Colors and Gray Scale of Colors

< Table 7. Input Signal and Display Color Table >

Color & Gray Scale		Input Data Signal																							
		Red Data								Green Data								Blue Data							
		R7	R6	R5	R4	R3	R2	R1	R0	G7	G6	G5	G4	G3	G2	G1	G0	B7	B6	B5	B4	B3	B2	B1	B0
Basic Colors	Black	0	0	0	0	0	0	0	0	0	0	0	0	0	0	0	0	0	0	0	0	0	0	0	
	Blue	0	0	0	0	0	0	0	0	0	0	0	0	0	0	0	0	1	1	1	1	1	1	1	1
	Green	0	0	0	0	0	0	0	0	1	1	1	1	1	1	1	1	0	0	0	0	0	0	0	0
	Cyan	0	0	0	0	0	0	0	0	1	1	1	1	1	1	1	1	1	1	1	1	1	1	1	1
	Red	1	1	1	1	1	1	1	1	0	0	0	0	0	0	0	0	0	0	0	0	0	0	0	0
	Magenta	1	1	1	1	1	1	1	1	0	0	0	0	0	0	0	0	1	1	1	1	1	1	1	1
	Yellow	1	1	1	1	1	1	1	1	1	1	1	1	1	1	1	1	0	0	0	0	0	0	0	0
	White	1	1	1	1	1	1	1	1	1	1	1	1	1	1	1	1	1	1	1	1	1	1	1	1
Gray Scale of Red	Black	0	0	0	0	0	0	0	0	0	0	0	0	0	0	0	0	0	0	0	0	0	0	0	
	△	0	0	0	0	0	0	0	1	0	0	0	0	0	0	0	0	0	0	0	0	0	0	0	
	Darker	0	0	0	0	0	0	1	0	0	0	0	0	0	0	0	0	0	0	0	0	0	0	0	
	△	↑								↑								↑							
	▽	↓								↓								↓							
	Brighter	1	1	1	1	1	1	0	1	0	0	0	0	0	0	0	0	0	0	0	0	0	0	0	0
	▽	1	1	1	1	1	1	1	0	0	0	0	0	0	0	0	0	0	0	0	0	0	0	0	0
	Red	1	1	1	1	1	1	1	1	0	0	0	0	0	0	0	0	0	0	0	0	0	0	0	0
Gray Scale of Green	Black	0	0	0	0	0	0	0	0	0	0	0	0	0	0	0	0	0	0	0	0	0	0	0	
	△	0	0	0	0	0	0	0	0	0	0	0	0	0	0	0	1	0	0	0	0	0	0	0	
	Darker	0	0	0	0	0	0	0	0	0	0	0	0	0	0	1	0	0	0	0	0	0	0	0	
	△	↑								↑								↑							
	▽	↓								↓								↓							
	Brighter	0	0	0	0	0	0	0	0	1	1	1	1	1	1	0	1	0	0	0	0	0	0	0	0
	▽	0	0	0	0	0	0	0	0	1	1	1	1	1	1	1	0	0	0	0	0	0	0	0	0
	Green	0	0	0	0	0	0	0	0	1	1	1	1	1	1	1	1	0	0	0	0	0	0	0	0
Gray Scale of Blue	Black	0	0	0	0	0	0	0	0	0	0	0	0	0	0	0	0	0	0	0	0	0	0	0	
	△	0	0	0	0	0	0	0	0	0	0	0	0	0	0	0	0	0	0	0	0	0	0	1	
	Darker	0	0	0	0	0	0	0	0	0	0	0	0	0	0	0	0	0	0	0	0	0	0	1	
	△	↑								↑								↑							
	▽	↓								↓								↓							
	Brighter	0	0	0	0	0	0	0	0	0	0	0	0	0	0	0	0	1	1	1	1	1	1	0	1
	▽	0	0	0	0	0	0	0	0	0	0	0	0	0	0	0	0	1	1	1	1	1	1	1	0
	Blue	0	0	0	0	0	0	0	0	0	0	0	0	0	0	0	0	1	1	1	1	1	1	1	1
Gray Scale of White	Black	0	0	0	0	0	0	0	0	0	0	0	0	0	0	0	0	0	0	0	0	0	0	0	
	△	0	0	0	0	0	0	0	1	0	0	0	0	0	0	0	1	0	0	0	0	0	0	1	
	Darker	0	0	0	0	0	0	1	0	0	0	0	0	0	0	1	0	0	0	0	0	0	0	1	
	△	↑								↑								↑							
	▽	↓								↓								↓							
	Brighter	1	1	1	1	1	1	0	1	1	1	1	1	1	1	0	1	1	1	1	1	1	1	0	1
	▽	1	1	1	1	1	1	1	0	1	1	1	1	1	1	1	0	1	1	1	1	1	1	1	0
	White	1	1	1	1	1	1	1	1	1	1	1	1	1	1	1	1	1	1	1	1	1	1	1	1

5.4 Power Sequence

To prevent a latch-up or DC operation of the Open Cell, the power on/off sequence shall be as shown in below



< Table 8. Sequence Table >

Parameter	Values			Units
	Min	Typ	Max	
T1	0.5	-	20	ms
T2	10	-	-	ms
T3	200	-	-	ms
T4	100	-	-	ms
T5	0	-	-	ms
T6	1	-	-	s

Notes: 1. Back Light must be turn on after power for logic and interface signal are valid.

2. Even though T1 is out of SPEC, it is still ok if the inrush current of VDD is below the limit.

6.0 MINI-LVDS SIGNAL SPECIFICATIONS

< Table 9. Timing Table >

Symbol	Parameter	Min	Typ	Max	Unit
F_M	Mini-LVDS Clock frequency	-	-	400	MHz
F_{MLVMOD}	Modulating frequency of input clock during SSC	-	-	600	KHz
F_{MLVDEV}	Maximum deviation of input clock frequency during SSC	-3	-	+3	%
$V_{IH_{LVDS}}$	Mini-LVDS high input voltage	200	-	-	mV
$V_{IL_{LVDS}}$	Mini-LVDS high input voltage	-	-	-200	mV
tSETUP	Data setup time	0.5	-	-	ns
tHOLD	Data hold time	0.5	-	-	ns

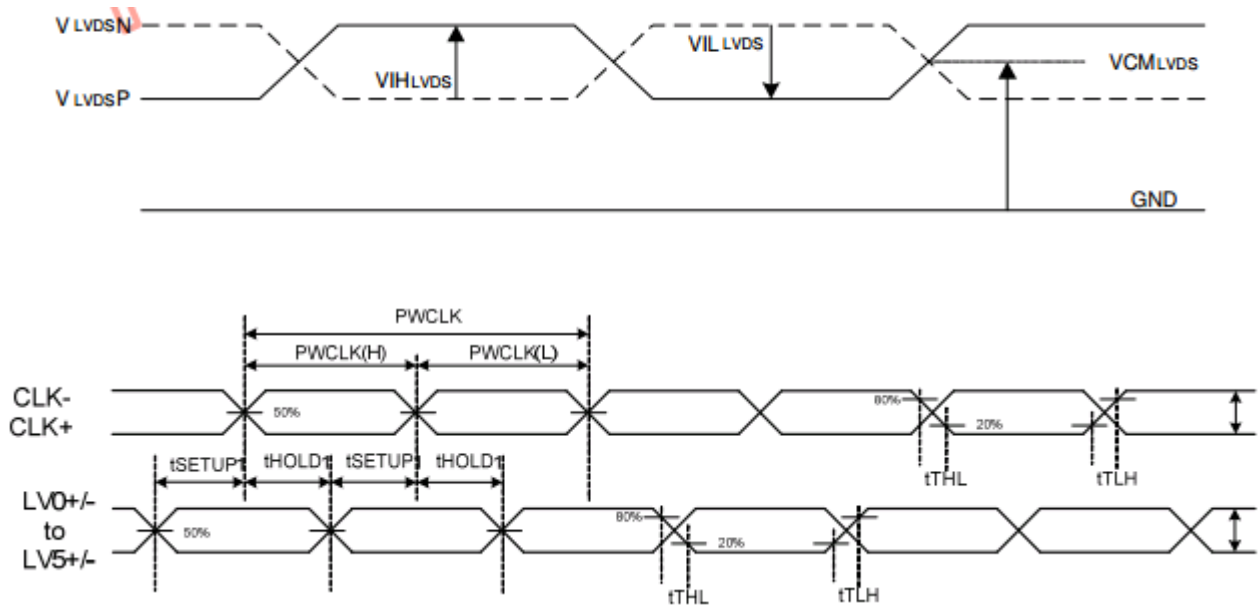

8 前框图纸:

